

**EG**

**Rhinologie  
Rhinology  
Rhinologie  
Rinología  
Rinologia**



**EG**



**EG-500-01** Fig. 1  
**EG-500-02** Fig. 2  
**EG-500-03** Fig. 3  
**EG-500-04** Fig. 4



**EG-500-05** Fig. 5  
**EG-500-06** Fig. 6  
**EG-500-07** Fig. 7

THUDICHUM  
 EA-500-01 - EA-500-07



**EG-600-01**  
 Fig. 1



**EG-600-02**  
 Fig. 2



**EG-600-03**  
 Fig. 2



VOLTOLINI  
 EG-600-01 - EG-600-03



**EG-012-01**  
 Fig. 1



**EG-012-02**  
 Fig. 2



**EG-012-03**  
 Fig. 3



HARTMANN-HALLE  
 EG-012-01 - EG-012-03  
 15 cm



Mod. Wien • Vienna •  
 Vienne • Viena

Baby • Bébé **EG-112-01**  
 Kind • child • enf. • niño • bamb. **EG-112-02**  
 Erw. • Adult. **EG-112-03**



Mod. Wien • Vienna  
 Vienne • Viena  
**EG-113-03**  
 leichtes Modell  
 lightweight  
 mod. léger  
 mod. ligero  
 mod. leggero



**TIECK-HALLE**  
**EG-116-13**  
 13,5 cm



**KILLIAN**  
**EG-210-35 - EG-210-90**  
 13,5 cm

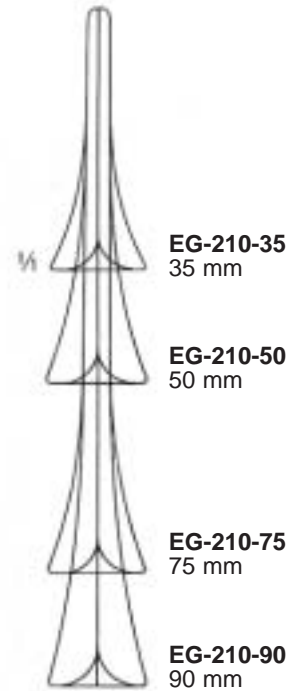

**EG-210-35**  
 35 mm

**EG-210-50**  
 50 mm

**EG-210-75**  
 75 mm

**EG-210-90**  
 90 mm



**COTTLE**  
**EG-214-35 - EG-214-90**  
 14 cm



**COTTLE**  
**EG-216-35 - EG-216-90**  
 schwarz • black • noirs  
 negros • neri  
 14 cm

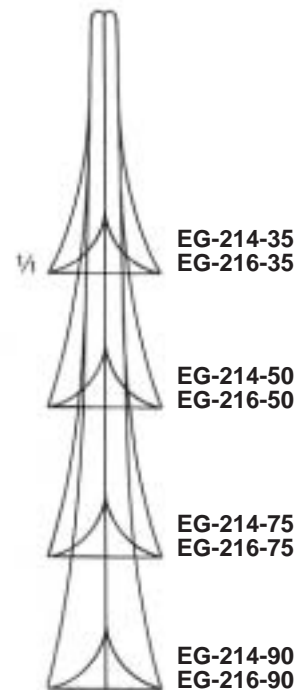

**EG-214-35**  
**EG-216-35**

**EG-214-50**  
**EG-216-50**

**EG-214-75**  
**EG-216-75**

**EG-214-90**  
**EG-216-90**



**YANKAUER**  
**EG-311-19**  
19 cm

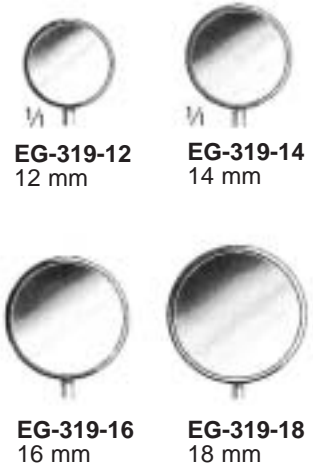

**EG-319-12**  
12 mm

**EG-319-14**  
14 mm

**EG-319-16**  
16 mm

**EG-319-18**  
18 mm

**MICHEL**  
**EG-319-12 - EG-319-18**  
25 cm



**TROELTSCH**  
**EG-511-15**  
15 cm

**TROELTSCH**  
**EG-511-18**  
18 cm



**JANSEN**  
**EG-514-20**  
20 cm



**HARTMANN**  
**EG-611-16**  
16 cm



**HARTMANN**  
**EG-611-20**  
20 cm

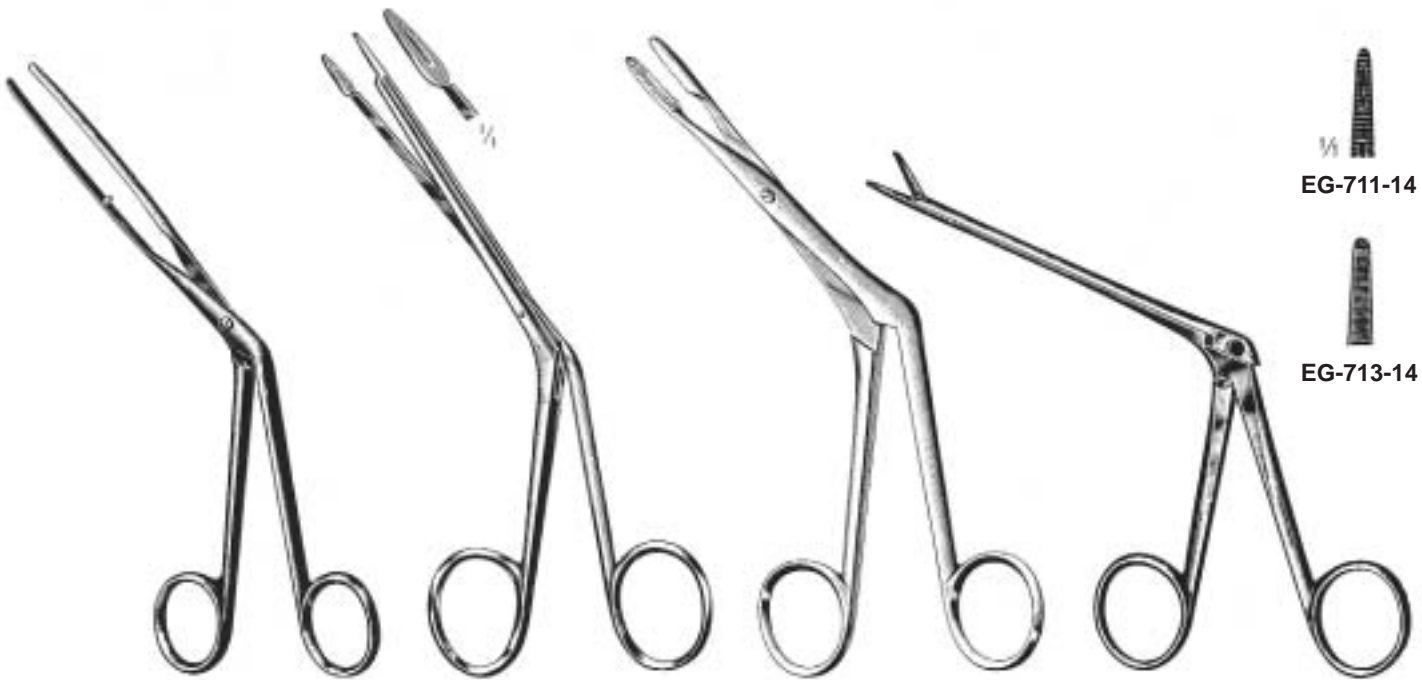

LUBET-BARBON  
EG-615-20  
20 cm

LITTAUER  
EG-617-18  
18 cm

HEYMANN-KNIGHT  
EG-619-18  
18 cm

NOYES  
EG-711-14 - EG-713-14  
14,5 cm



EG-811-01

EG-811-02

EG-811-03

HEYMANN  
EG-811-01 - EG-811-03  
18 cm

KNIGHT  
EG-815-18  
18 cm

BRUENINGS  
EG-911-01 - EG-911-04  
19 cm

EG-911-01

EG-911-02

EG-911-03

EG-911-04



**EG-915-01** **EG-915-02**  
 Fig. 1 Fig. 2

LUC  
**EG-915-01 - EG-915-02**  
 19 cm

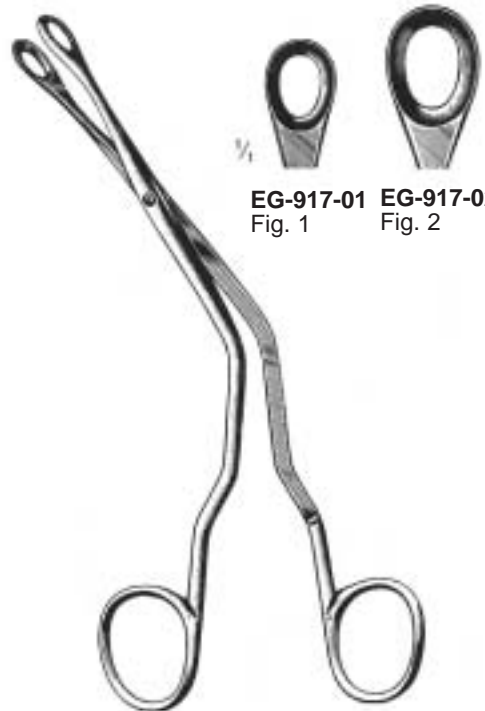

**EG-917-01** **EG-917-02**  
 Fig. 1 Fig. 2

LUC  
**EG-917-01 - EG-917-02**  
 19 cm

ohne Hals  
 without neck  
 sans cou  
 sin cuello  
 senza collo

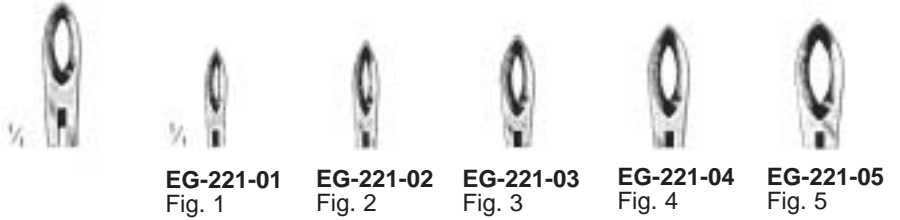

**EG-221-01** **EG-221-02** **EG-221-03** **EG-221-04** **EG-221-05**  
 Fig. 1 Fig. 2 Fig. 3 Fig. 4 Fig. 5

mit Hals  
 with neck  
 avec cou  
 con cuello  
 con collo



**EG-223-01** **EG-223-02** **EG-223-03** **EG-223-04** **EG-223-05**  
 Fig. 1 Fig. 2 Fig. 3 Fig. 4 Fig. 5



WEIL-BLAKESLEY  
**EG-221-01 - EG-223-05**

Scharfe Nasenzangen  
 Nasal Cutting Forceps  
 Pincès coupantes nasales  
 Pinzas cortantes nasales  
 Pinze taglienti nasali



**EG-321-01-EG-327-03**  
 19 cm



**STRUYCKEN**  
**EG-321-01**  
 Fig. 1



**STRUYCKEN**  
**EG-321-02**  
 Fig. 2

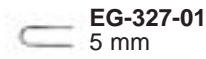

**EG-327-01**  
 5 mm



**EG-327-02**  
 7 mm

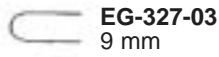

**EG-327-03**  
 9 mm



**MYLES**



**EG-325-05**



**EG-325-07**



**EG-325-09**



**EG-325-11**



**HARTMANN**



Septum- Quetschzange  
 Septum Crushing Forceps  
 Pince à éraiser la cloison  
 Pinza para magullar tabique  
 Pinza per ammaccare il setto

**RUBIN**  
**EG-521-21**  
 21 cm



mm x mm	KERRISON
3 x 3	<b>EG-033-03</b>
4 x 4	<b>EG-033-04</b>
5 x 5	<b>EG-033-05</b>
6 x 6	<b>EG-033-06</b>

17 cm

 **EG-035-01**  
3, 5 mm

 **EG-035-02**  
3, 5 mm



**HAJEK-KOFLER**  
**EG-035-01 - EG-035-02**

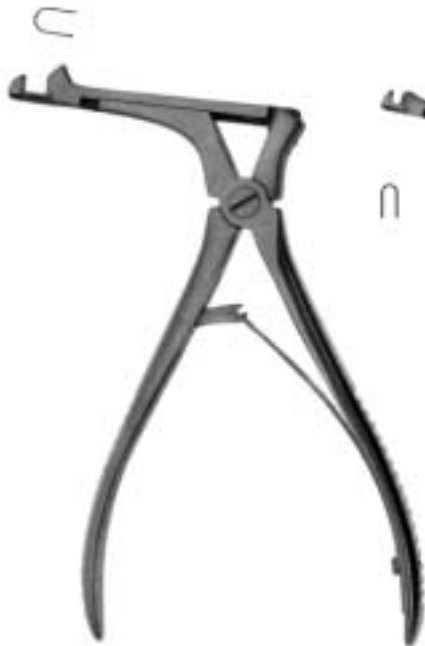

mm	CITELLI
1,0	<b>EG-131-10</b>
2,5	<b>EG-131-25</b>
4,0	<b>EG-131-40</b>



**BEYER**  
**EG-135-20**  
2,0 mm



**HAJEK-CLAUS**  
**EG-230-20**  
20 mm



MIDDLETON-JANSEN  
**EG-233-19**  
 19 cm



MIDDLETON-JANSEN  
**EG-235-19**  
 19 cm



ø mm	LICHTWITZ
1,5	<b>EG-430-15</b>
1,8	<b>EG-430-18</b>
2,0	<b>EG-430-20</b>

Luer-Lock  
 10 cm



KILLIAN  
**EG-431-03**  
 14 cm/3 mm ø



KRAUSE  
**EG-531-26**  
 26 cm



WILDE  
**EG-532-24**  
 24 cm



WILDE  
**EG-535-03**  
 0,3 mm



JOSEPF  
 EG-730-16 - EG-733-16



EG-730-16  
 stumpf • blunt • mousses  
 romos • smussi



EG-731-16



EG-732-16  
 spitz • pinted • pointus  
 puntiagudos • acuti



EG-733-16



FREER  
 EG-734-15  
 15 cm



FREER  
 EG-735-19  
 19cm



JOSEPH  
 EG-736-16  
 16 cm



CONVERSE  
 EG-739-16  
 16 cm



CONVERSE  
 EG-830-15  
 15 cm



EG-832-15



COTTLE  
 EG-834-15



EG-835-15

Septum-Messer  
 Septum Knives  
 Couteaux pour la cloison  
 Cuchillos para tabique  
 Coltelli per setto

**EG**

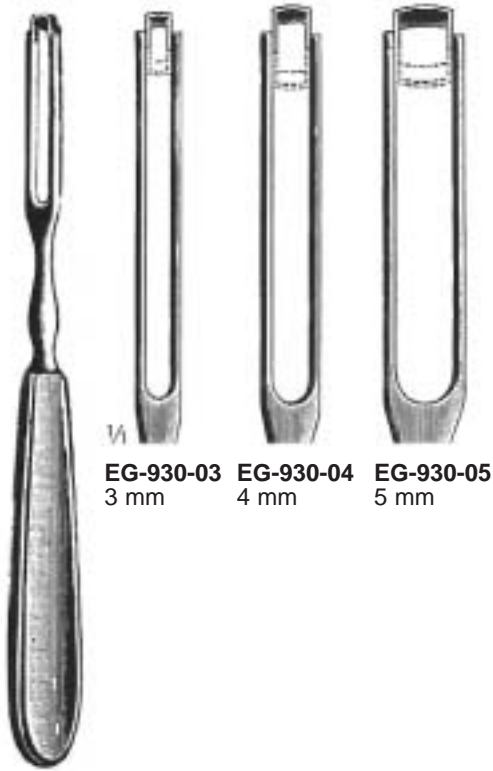

**EG-930-03** 3 mm  
**EG-930-04** 4 mm  
**EG-930-05** 5 mm

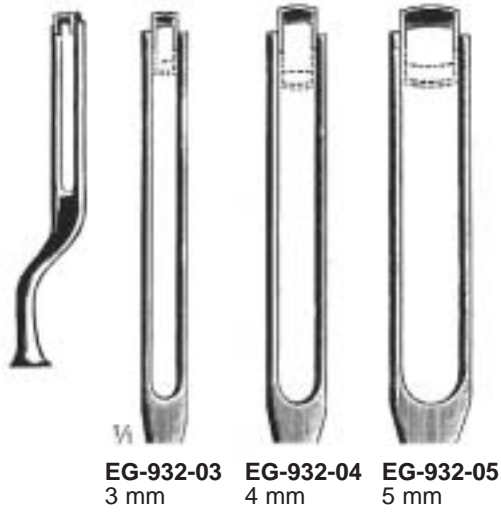

**EG-932-03** 3 mm  
**EG-932-04** 4 mm  
**EG-932-05** 5 mm



**BRUENINGS**  
**EG-938-16**  
 16,5 cm

**BALLENGER**  
**EG-930-03 - EG-932-05**  
 20 cm

Septum-Elevatorien  
 Septum Elevators  
 Elevateurs pour la cloison nasale  
 Elevadores para tabique  
 Elevatori per setto

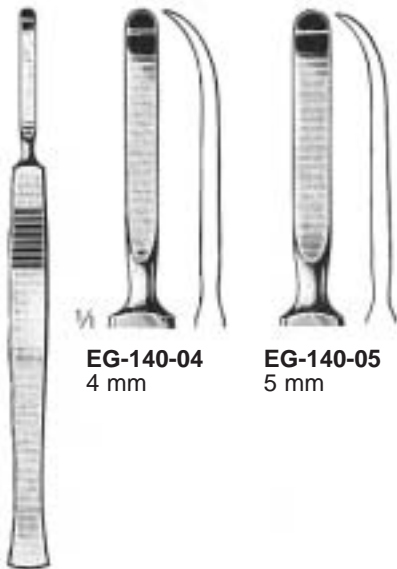

**EG-140-04** 4 mm  
**EG-140-05** 5 mm

**McKENTY**  
**EG-140-04 - EG-140-05**  
 15 cm

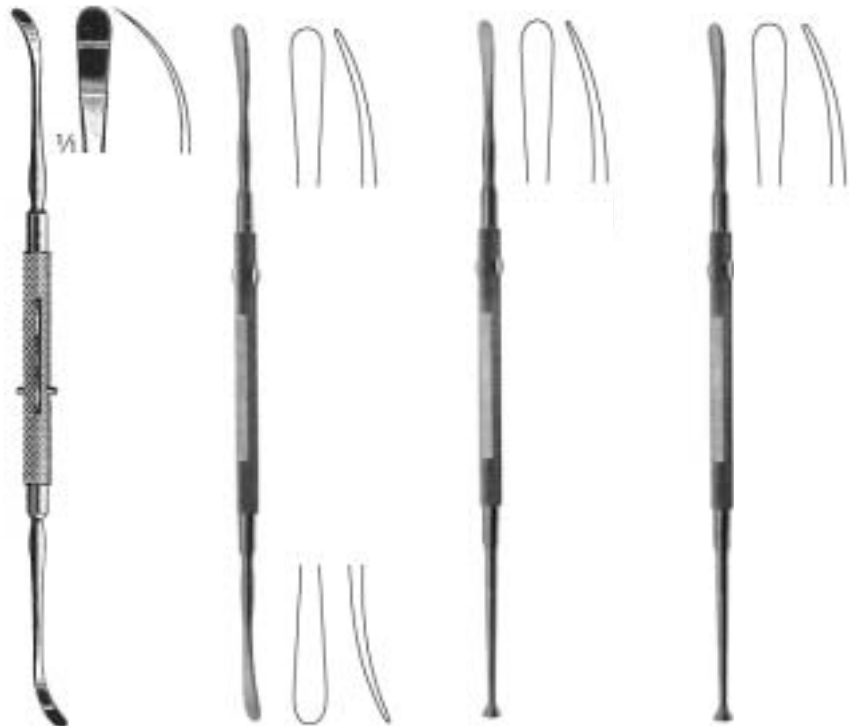

**ROGER**  
**EG-143-19**  
 19 cm

**FREER**  
**EG-145-18**  
 18 cm

**FREER**  
**EG-147-19**  
 19 cm

**FREER**  
**EG-149-19**  
 19 cm



**COTTLE**  
**EG-241-23**  
23 cm



**COTTLE**  
**EG-243-22**  
22 cm



**JOSEPH**  
**EG-245-16**  
16 cm



**COTTLE**  
**EG-245-19**  
19cm



**KILLIAN**  
**EG-246-22**  
19cm



**HAJEK-BALLENGER**  
**EG-248-21**  
22 cm



**BALLENGER**  
**EG-340-22**  
2 cm



**FREER**  
**EG-540-04**  
4 mm



**FREER**  
**EG-541-04**  
4 mm



**EG-544-04**  
4 mm

**EG-544-07**  
7 mm

**EG-544-09**  
9 mm

**EG-544-12**  
12 mm

**COTTLE**  
**EG-544-04 - EG-544-12**  
 18 cm



**COTTLE**  
**EG-545-06**  
 18 cm/6 mm

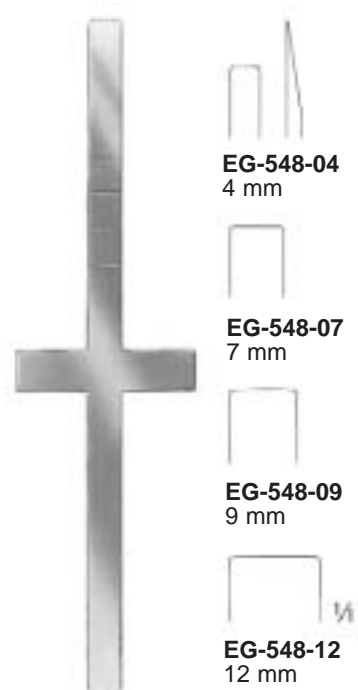

**EG-548-04**  
4 mm

**EG-548-07**  
7 mm

**EG-548-09**  
9 mm

**EG-548-12**  
12 mm

**COTTLE**  
**EG-548-04 - EG-548-12**

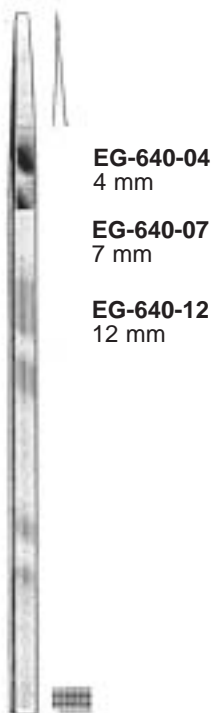

**EG-640-04**  
4 mm

**EG-640-07**  
7 mm

**EG-640-12**  
12 mm

**COTTLE**  
**EG-640-04 - EG-640-12**  
 18 cm

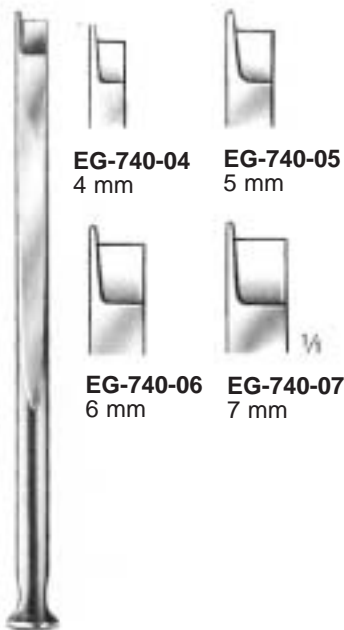

**EG-740-04**  
4 mm

**EG-740-05**  
5 mm

**EG-740-06**  
6 mm

**EG-740-07**  
7 mm

**FOMON**  
**EG-740-04 - EG-740-07**  
 17 cm

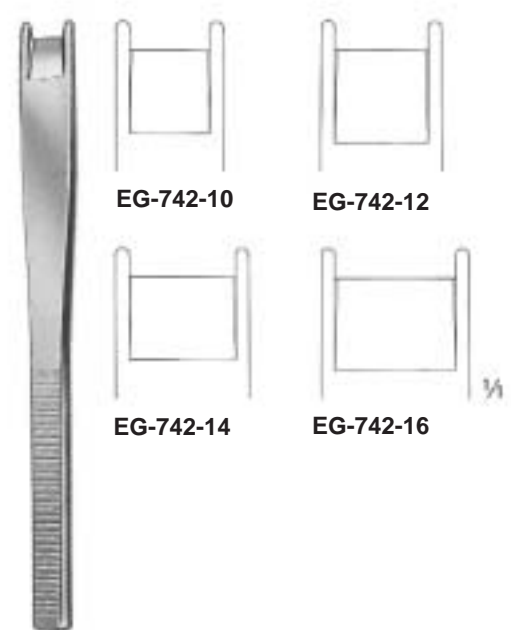

**EG-742-10**

**EG-742-12**

**EG-742-14**

**EG-742-16**

**FOMON**  
**EG-742-10 - EG-742-16**

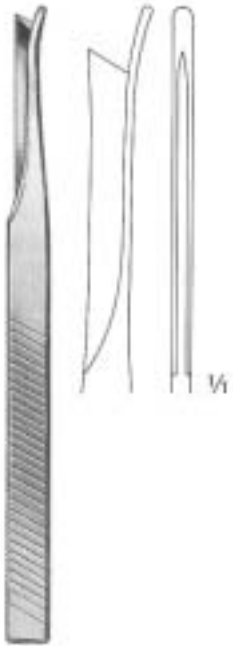

SILVER  
**EG-743-01**  
18 cm

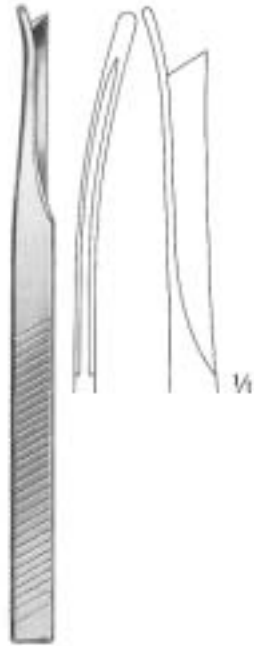

SILVER  
**EG-743-02**  
18 cm



SILVER  
**EG-743-03**  
18 cm



KILLIAN-CLAUS  
**EG-842-05**  
17 cm/5 mm



mm	HAJEK
4	<b>EG-844-04</b>
6	<b>EG-844-06</b>
8	<b>EG-844-08</b>



WEST  
**EG-846-16**  
16 cm



WEST  
**EG-847-16**  
16 cm



FREER  
**EG-849-16**  
6 mm

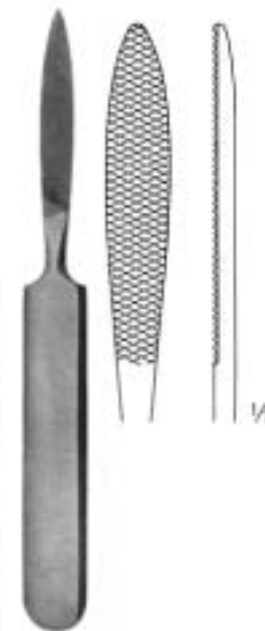

JOSEPH  
**EG-052-16**  
16 cm

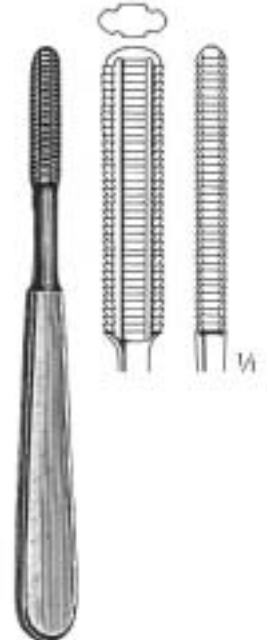

MALTZ  
**EG-054-18**  
18 cm



WIENER  
EG-057-18 - EG-057-19  
18 cm



EG-057-18



EG-057-19



WIENER (AUFRICHT)  
EG-151-21 - EG-153-21  
21 cm



EG-151-21

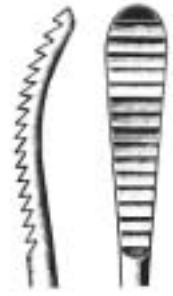

EG-153-21



JOSEPH (LEWIS)  
EG-154-16 - EG-156-16  
18 cm



EG-154-16  
fein • fine  
fina



EG-156-16  
grob • coarse • gruesa  
entellure grosse  
dentellatura grossa



MALTZ (COTTLE)  
EG-158-21  
21 cm

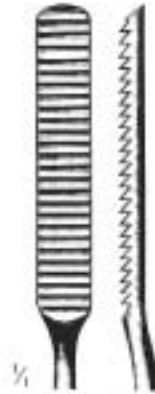

FOMON  
EG-250-21  
21 cm

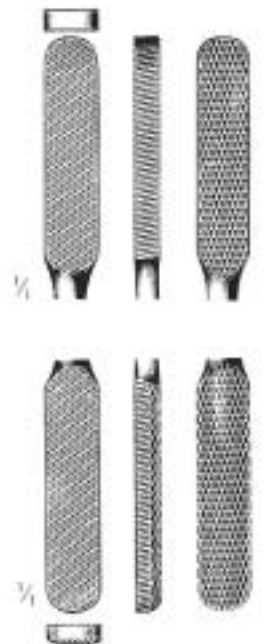



FOMON  
20 cm TC



Fig. 1/2  
EG-252-01



Fig. 3/4  
EG-252-03



Fig. 5/6  
EG-252-05



Fig. 7/8  
EG-252-07

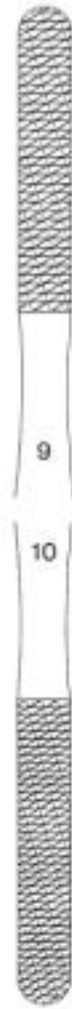

Fig. 9/10  
EG-252-09



Fig. 1



Fig. 2

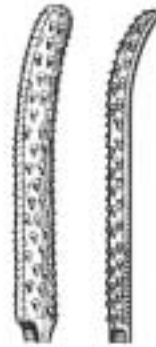

Fig. 3



GALLAHER

EG-256-16

EG-257-16

EG-259-16

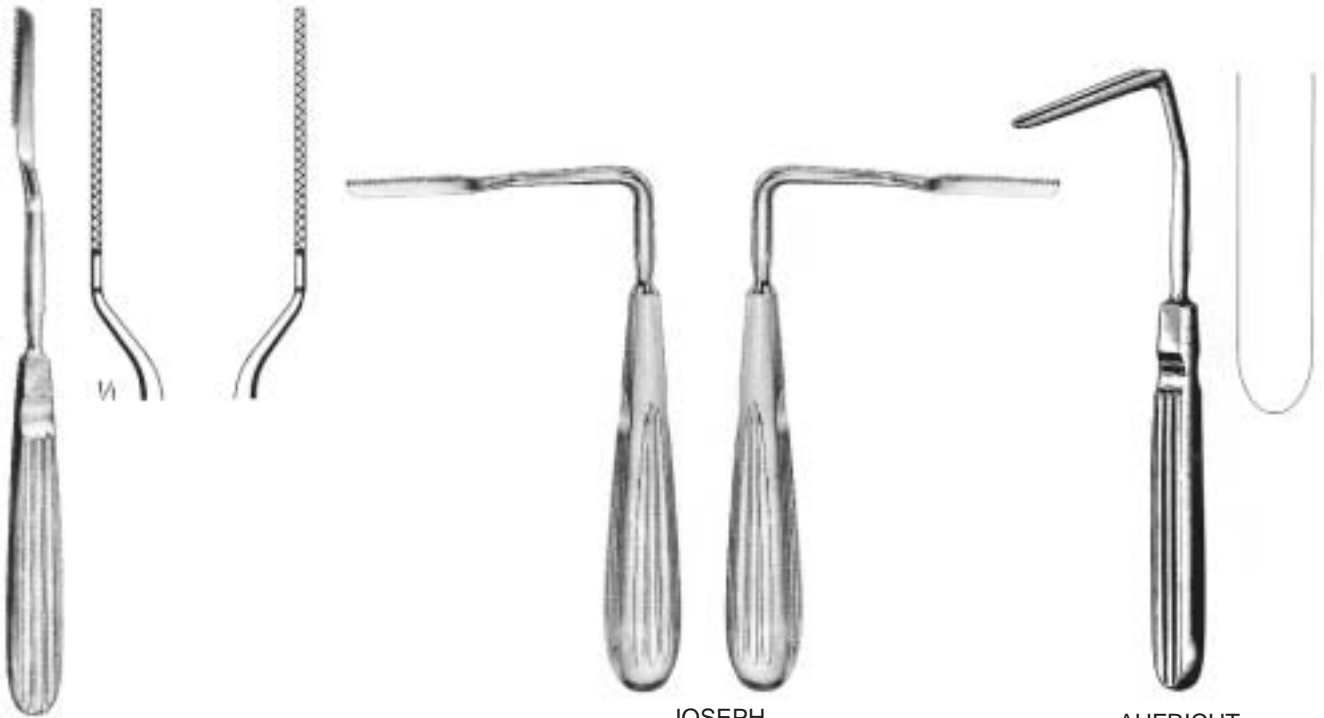

JOSEPH  
EG-355-01 17 cm EG-355-01

AUFRICHT  
EG-551-16  
19 cm

JOSEPH  
19 cm  
EG-352-19 links • left  
à gauche  
izquierda  
a sinistra  
EG-354-19 rechts • right •  
á droite  
derecha  
a destra



COTTLE  
EG-556-14

FOMON  
EG-556-16

FOMON  
EG-557-17

COTTLE-NEIVERT  
EG-559-20

Fig. 1 GILLIES  
EG-650-18  
Fig. 2 EG-652-18  
18 cm



ASCH  
EG-751-23  
23 cm



WALSHAM  
EG-752-23 - EG-755-23  
23 cm



EG-752-23  
gerade  
straight  
droite  
recta  
retta



EG-753-23  
links  
left  
à gauche  
izquierda  
a sinistra



EG-755-23  
rechts  
right  
à droite  
derecha  
a destra



JATHO  
EG-955-15



FAULKNER  
EG-061-21  
21 cm



EG-067-01  
Fig. 1



EG-067-02  
Fig. 2



EG-067-02  
Fig. 3



EG-067-04  
Fig. 4



EG-067-05  
Fig. 5



EG-067-06  
Fig. 6



COAKLEY  
EG-067-01 - EG-067-06  
17 cm



**EG-260-01**  
Fig. 1



**EG-260-02**  
Fig. 2



**BECKMANN**  
**EG-260-01 - EG-260-06**  
22 cm



**EG-260-03**  
Fig. 3



**EG-260-04**  
Fig. 4



**EG-260-05**  
Fig. 5



**EG-260-06**  
Fig. 6



**BARNHILL**  
**EG-360-01 - EG-360-04**  
21 cm



**EG-360-01**  
Fig. 1



**EG-360-02**  
Fig. 2



**EG-360-03**  
Fig. 3



**EG-360-04**  
Fig. 4



**EG-461-01**  
Fig. 1



**EG-461-02**  
Fig. 2



**EG-461-03**  
Fig. 3

Ersatzklingen, gelocht  
Spare blades, perforated  
Lames de rechange, perforées  
Hojas de repuesto, perforadas  
Lame di ricambio, forate

Fig.

- |   |                  |
|---|------------------|
| 1 | <b>EG-462-01</b> |
| 2 | <b>EG-462-02</b> |
| 3 | <b>EG-462-03</b> |



**St. CLAIR-THOMSON**  
**EG-366-01 - EG-366-04**  
21 cm



**EG-366-01**  
Fig. 1



**EG-366-03**  
Fig. 3



**EG-366-02**  
Fig. 2



**EG-366-04**  
Fig. 4



**LAFORCE**  
**EG-461-01 - EG-641-03**  
25 cm

